

Operating Instructions

FM/AM DIGITAL SYNTHESIZER TUNER

F-225L/F-225

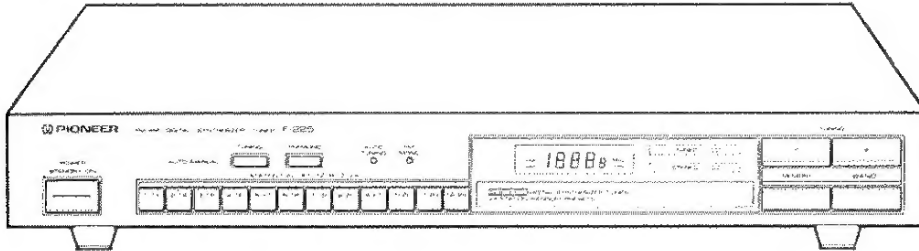

Thank you for buying this Pioneer product. Please read through these operating instructions so you will know how to operate your model properly. After you have finished reading the instructions, put them away in a safe place for future reference.

In some countries or regions, the shape of the power plug and power outlet may sometimes differ from that shown in the explanatory drawings. However, the method of connecting and operating the unit is the same.

WARNING: TO PREVENT FIRE OR SHOCK HAZARD, DO NOT EXPOSE THIS APPLIANCE TO RAIN OR MOISTURE.

IMPORTANT NOTICE [For U.S. and Canadian models]

The serial number for this equipment is located on the rear panel. Please write this serial number on your enclosed warranty card and keep it in a secure area. This is for your security.

[For Canadian model]

CAUTION: TO PREVENT ELECTRIC SHOCK DO NOT USE THIS (POLARIZED) PLUG WITH AN EXTENSION CORD, RECEPTACLE OR OTHER OUTLET UNLESS THE BLADES CAN BE FULLY INSERTED TO PREVENT BLADE EXPOSURE.

ATTENTION: POUR PREVENIR LES CHOCs ELECTRIQUES NE PAS UTILISER CETTE FICHE POLARISEE AVEC UN PROLONGATEUR UNE PRISE DE COURANT OU UNE AUTRE SORTIE DE COURANT, SAUF SI LES LAMES PEUVENT ETRE INSEREES A FOND SANS EN LAISSER AUCUNE PARTIE A DECOUVERT.

LINE VOLTAGE SELECTOR SWITCH

Only multi-voltage models are provided with this switch. U.S., Canadian, European, U.K., and Australian models are not provided with this switch. Mains voltages in Saudi Arabia are 127V and 220V only. Never use this model with 110V setting in Saudi Arabia.

The line voltage selector switch is on the rear panel. Before your model is shipped from the factory, this switch is set to the power requirements of the destination. Check that it is set properly before plugging the power cord into the AC wall socket. If the voltage is not properly set or if you move to an area where the voltage requirements differ, adjust the selector switch as follows.

1. Use a medium-size screwdriver.
2. Insert the screwdriver into the groove on the voltage selector, and adjust so that the tip of the arrow points to the voltage value of your area.

Set the voltage selector for the voltage in your area.

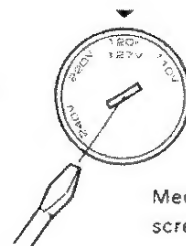

Medium-size screwdriver

CONTENTS

Features	4	Operations	8
Checking the Accessories	4	Troubleshooting	9
Antenna Connections	5	Specifications	10
Connections	6		
Names and Uses of Parts	7		

FM/AM CHANNEL STEP SWITCH

(Following explanations do not apply to models without the CHANNEL STEP switch on the rear panel.)

Only multi-voltage models are provided with this switch. U.K., and Australian models are not provided with this switch.

The AM/FM channel step switch is located on the rear panel of the digital synthesizer tuner. Before the tuner leaves the factory, this switch is set to the channel allotment plan of the area in which the tuner is sold. When the TUNING switch is given a single push, the frequency display will change in following unit.

[100 kHz/10 kHz] position:

Set to this position for areas with FM reception step of 100 kHz and AM 10 kHz.

[50 kHz/9 kHz] position:

Set to this position for areas with FM reception step of 50 kHz and AM 9 kHz.

NOTE:

When unsure about the channel allocation for your area, consult your dealer for correct information.

The channel step will not change if the CHANNEL STEP switch is operated with the power ON.

After operating the CHANNEL STEP switch, if you turn the POWER switch OFF and then ON again, the channel step will switch over.

If you operate the CHANNEL STEP switch, the stations that were memorized before the switch was operated will be erased.

ANTENNA CONNECTIONS

Radio reception is not possible unless the antenna is properly connected.

The strength of broadcast signals varies from one area to another. Signal propagation is especially poor in metropolitan areas, where there are many tall buildings, and in mountainous areas. Proper antenna installation is vital to good reception.

AM ANTENNA

The AM loop antenna supplied with the tuner should be connected to the AM antenna terminals. The antenna should be placed at a distance from the tuner, and should not be allowed to touch metallic objects. Avoid placing it near CD players, personal computers, television sets, and other devices generating radio frequencies.

Setting Up the AM Antenna

- Fold out the supports on the bottom of the antenna. Insert the stopper in the hole in the antenna to lock them in place.
- Place the antenna on a level surface and rotate it to locate the orientation that yields the best reception.

AM Loop Antenna Set-up

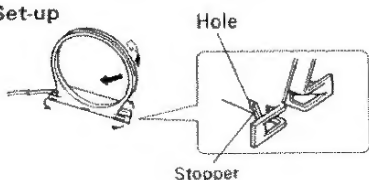

AM Loop Antenna Connection

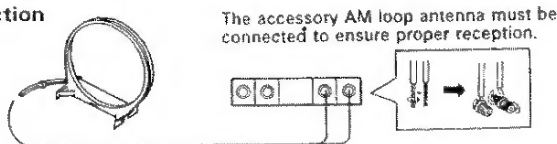

External AM antenna

Indoor AM antenna

Provide a vinyl-coated wire (5 to 6 meters long). Secure one end to the AM terminal and the other end to a wall or other high location.

Outdoor AM antenna

If reception is still poor even when a lead antenna has been stretched out indoors, stretch out a vinyl-coated wire and secure it outdoors.

Connecting the external AM antenna

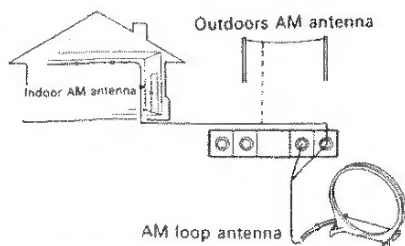

NOTE:

Do not detach the AM loop antenna when using the external AM antenna.

FM ANTENNA

FM T-type Antenna Attachment

Connect the accessory FM T-type antenna to the FM terminals. Stretch the antenna out to its full length, and affix it to a wall, etc.

Stretch out both ends.

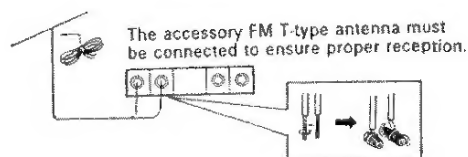
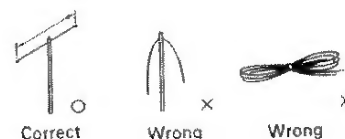

External FM antenna installation

Use an external antenna when the signals from the station are weak and cannot be picked up by the accessory T-type FM antenna, or when the sound heard is accompanied by large amounts of noise. There are two ways of connecting the external FM antenna to the ANTENNA terminals: with 300Ω feeder wire, or with a 75Ω coaxial cable.

It is recommended that you use the 75Ω coaxial cable, so that the effects of extraneous noise are reduced to a minimum.

When the connecting cable is a 75Ω coaxial cable

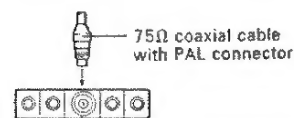
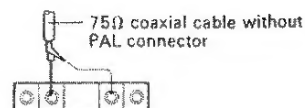

This terminal is provided on the U.K. and Australian models.

When the connecting cable is a 300Ω feeder wire

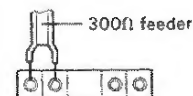

NAMES AND USES OF PARTS

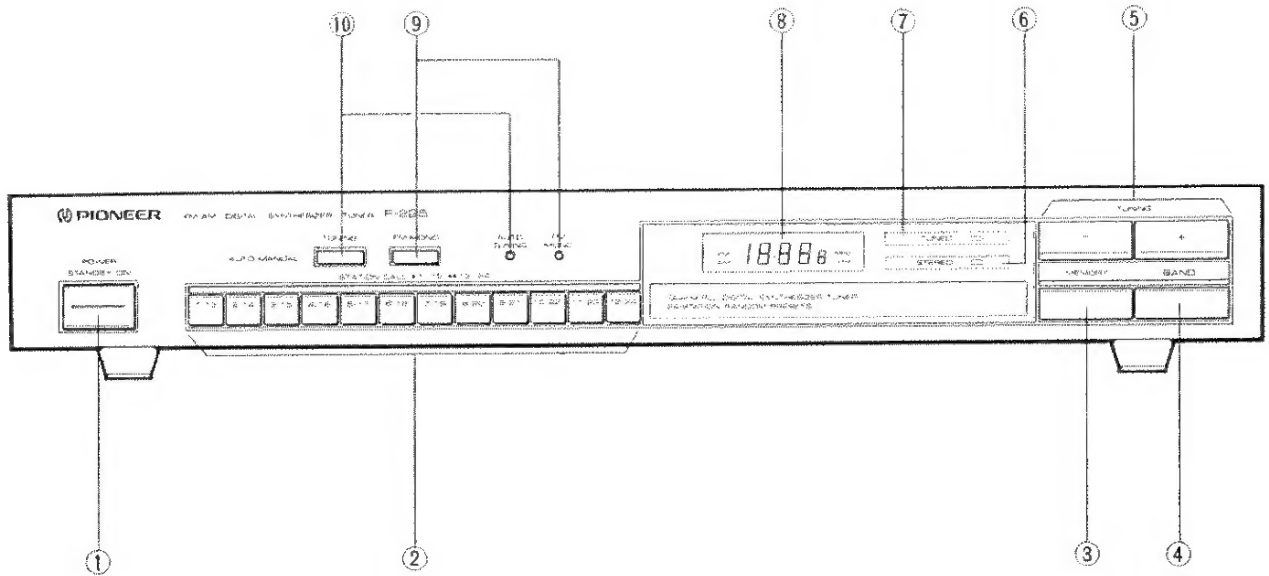

① POWER (STANDBY/ON) switch

When this switch is set to the ON position, power is supplied to the tuner's main circuits. The POWER unit's switch is geared to selecting the transformer's secondary so that even in the STANDBY position, the unit's circuitry will work as long as the power cord is connected to a power outlet. Disconnect the power cord from the power outlet when you do not plan to use the unit for a long period of time.

NOTE:

*The memory will be backed up so long as the power cord is not unplugged.
If the power cord is unplugged, the memory will be retained for several days.*

② STATION CALL switches

These are used to recall memorized broadcasting stations and to memorize the station.

③ MEMORY switch

This switch is used to memorize stations. When the switch is pressed, the frequency indicator will flash. To memorize the frequency of any station, press the STATION CALL switch while the frequency display is flashing.

④ BAND selector switch

This is used to select the band of the desired station. The bands change alternately each time the switch is pressed.

(F-225)

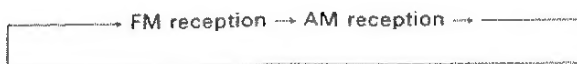

(F-225L)

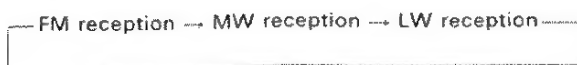

⑤ TUNING switches

These are used to locate the stations. Push the "-" switch to go to a lower, and the "+" switch to go to a higher frequency.

⑥ STEREO indicator

This lights when a stereo program has been picked up during an FM broadcast.

⑦ TUNED indicator

This lights to indicate when the finest tuning of a station has been achieved.

⑧ FREQUENCY display

Permits reading the received frequency at a glance from the displayed figure. The FM band is indicated by MHz, and the AM band by kHz.

⑨ FM MONO switch/indicator

Normally this is set to the off position (the FM MONO indicator goes off). When noise spoils the reception of an FM program, press the switch to the on position (the FM MONO indicator will now light).

The program of an FM stereo broadcast will be heard in mono. The setting of the FM MONO switch (on or off) is memorized along with the station's frequency in the STATION CALL switches.

When using the memorize tuning feature, reception will be in the mode selected when the station was memorized. This switch will not function for AM reception.

⑩ AUTO/MANUAL tuning switch/indicator

Use to select either the AUTO mode or MANUAL mode for FM/AM reception. (When the auto tuning mode is selected, the AUTO indicator will now light.)

Memorized station tuning

(1) Press the STATION CALL switch into which the desired station has been memorized.

- To listen to a Mode 1 broadcast, press the switch once; and to listen to Mode 2 broadcast, press it twice.
- By pressing the STATION CALL switch, the switch number will be displayed, then the frequency will be displayed.

NOTE:

If, for example, you wish to receive the station memorized in STATION CALL switch "13", press switch "1/13" twice.

In this way, simple and accurate reception of any desired station is possible.

NOTE:

- The contents of the STATION CALL switch will be preserved for several days, even if the power cord is unplugged.
- If a memorized station has been erased, re-memorize it.

Last station memory

- When the POWER switch is pressed to turn power on, the last station received before the power was previously turned off will be received again.
- When power is ON, if the BAND selector switch is pressed, the last station received before the BAND selector switch was previously pressed will be received again.

TROUBLESHOOTING

Incorrect operations are often mistaken for trouble and malfunctions. If you think that there is something wrong with this component, check the points below. Sometimes the trouble may lie in another component. Investigate the other components and electrical appliances being used.

If the trouble cannot be rectified even after exercising the checks listed below, ask your nearest PIONEER authorized service center or your dealer to carry out repair work.

Symptom	Cause	Remedy
No power	<ul style="list-style-type: none"> • Has the power cord been disconnected? 	<ul style="list-style-type: none"> • Reconnect the power cord.
No sound	<ul style="list-style-type: none"> • Have any of the output cords been disconnected or incorrectly connected? • Has the antenna been disconnected or is the connection loose? • Has the power cord been unplugged for several days? (Station memory has been lost.) • Is the input selector on the amplifier set to TUNER? 	<ul style="list-style-type: none"> • Connect them properly to the TUNER terminals on the amplifier. • Connect the antenna properly. • Memorize the stations once again. • Select TUNER as the input source on your amplifier.
Sound distortion [On the FM band]	<ul style="list-style-type: none"> • Are the signals weak and reception poor? • Static from other appliances (particularly automobiles) or multipath reflection (radio waves beamed off mountains and tall buildings and not received directly.) 	<ul style="list-style-type: none"> • Substitute an FM outdoor antenna for the FM T-type antenna. • Set the FM MONO switch to ON (reception will be in monaural). • Try varying the height and direction of the antenna or use an FM outdoor antenna substituting a 75 Ω coaxial cable for the standard cable and fixing it as far away as possible from the street.
Sound distortion [On the AM (MW or LW) band]	<ul style="list-style-type: none"> • Is the AM loop antenna oriented poorly or located in an unsatisfactory position? • Static from other electrical appliances (fluorescent lights/motors?) 	<ul style="list-style-type: none"> • Change the direction of the antenna until best reception is obtained as far as possible from tuner. • Switch off other appliances or keep as far away as possible from the tuner when in use.
Stereo broadcasts not received in stereo.	<ul style="list-style-type: none"> • Are the signals weak, with insufficient input? • Is the FM MONO switch ON? 	<ul style="list-style-type: none"> • Change to an outdoor FM antenna. • Press the FM MONO switch OFF.

SPECIFICATIONS

FM Tuner Section

Frequency range	87.5 MHz to 108 MHz
Usable Sensitivity (IHF)	12.7 dBf (1.2 μ V/75 Ω)
50dB Quieting Sensitivity	Mono: 18 dBf (2.2 μ V/75 Ω) Stereo: 38.3 dBf (22.6 μ V/75 Ω)
Sensitivity (DIN)	Mono: 0.9 μ V/75 Ω Stereo: 31.5 μ V/75 Ω
Signal-to-Noise Ratio	Mono: 77 dB (at 85 dBf) Stereo: 73 dB (at 85 dBf)
Signal-to-Noise Ratio (DIN)	Mono: 62 dB Stereo: 60 dB
Distortion	0.5% (1 kHz)
Alternate Channel Selectivity	60 dB (400 kHz)
Stereo Separation	40 dB (1 kHz)
Frequency Response	30 Hz to 15 kHz \pm 1 dB
Image Response Ratio	38 dB
IF Response Ratio	110 dB
Antenna Input	300 Ω balanced 75 Ω unbalanced
Output	650mV (100% MOD.)/1.7k Ω

MW (AM) Tuner Section

Frequency range (10kHz/9kHz step)	530/531 kHz to 1,700/1,602 kHz
Sensitivity (IHF, Loop antenna)	350 μ V/m
Selectivity	20 dB
Signal-to-Noise Ratio	45 dB
Image Interference Ratio	40 dB
IF Interference Ratio	50 dB
Antenna	Loop Antenna
Output	150 mV (30% MOD.)/1.7k Ω

LW Tuner Section (F-225L only)

(For LW-equipped models only)	
Frequency range	153 kHz to 281 kHz
Sensitivity (IHF, Loop antenna)	1,500 μ V/m
Selectivity	20 dB
Signal-to-Noise Ratio	45 dB
Image Interference Ratio	30 dB
IF Interference Ratio	50 dB
Antenna	Loop Antenna
Output	150 mV (30% MOD.)/1.7k Ω

Miscellaneous

Power requirements	
U.K. and Australian models	a.c. 240 volts ~, 50/60 Hz
Other destination model	AC110/120-127/220/240V (switchable), 50/60 Hz

Power consumption	
U.K. model	10 W
Australian model	10 W
Other destination model	10 W
Dimensions	420 (W) \times 60 (H) \times 219 (D) mm 16-1/2 (W) \times 2-3/8 (H) \times 8-5/8 (D) in
Weight (without package)	2.2 kg (4 lb 14 oz)

Furnished Parts

FM T-type Antenna	1
AM Loop Antenna	1
Operating instructions	1
Connection cord with pin plug	1

NOTE:

- Specifications and design subject to possible modification without notice, due to improvements.

STATION CALL switch "memo"

It is recommended that you make a note of the memorize stations.

S.C. switch	•	1	2	3	4	5	6	7	8	9	10	11	12
Name of broadcast station													
Frequency													
S.C. switch	••	13	14	15	16	17	18	19	20	21	22	23	24
Name of broadcast station													
Frequency													

OPERATIONS

Listening to FM or AM broadcasts.

<Auto tuning can be used for both FM and AM (MW) reception.>

(1) Use the **AUTO/MANUAL** switch to select the auto tuning mode or the manual tuning mode.

- When the auto tuning mode is selected, the **AUTO TUNING** indicator will now light.

(2) Use the **BAND** selector switch to select either the **FM** or **AM (MW or LW)** reception band.

- For FM broadcasts, the "FM" and "MHz" indicators will light.
- For AM broadcasts, the "AM" and "kHz" indicators will light.

(3) Press the **- (Down)** or **+ (Up)** of the **TUNING** switches.

Auto tuning [FM, AM (MW)]:

The tuner will automatically search for a broadcasting station, and stop when one is found. To search for another station, press again.

Manual tuning [FM, AM (MW, LW)]:

The tuning frequency will change by one step each time the switch is pressed. Press as many times as necessary to tune in the desired station.

If the switch is held depressed, the reception frequency will change continuously, and stop when the switch is released.

(4) When you wish to receive a different station within the same band, repeat step (3). To receive a station on a different reception band, repeat steps (2) and (3).

(5) Adjust the volume and tone of the stereo amplifier.

NOTE:

When **AUTO TUNING** is in use, reception may not be possible when signals are weak. At these times **MANUAL TUNING** is recommended.

Memorizing FM and AM stations

You can memorize 12 FM and AM stations in Mode 1, and 12 stations in Mode 2, that is a total of 24 stations.

(1) Use the **BAND** selector switch to select either the **FM** or **AM** reception band.

- For FM broadcasts, the "FM" and "MHz" indicators will light.
- For AM broadcasts, the "AM" and "kHz" indicators will light.

(2) Use the **TUNING** switches to tune in the desired station.

When memorizing an FM station, either press the **FM MONO** switch to forcibly memorize the station in the monaural mode, or memorize the station in the auto stereo mode (with **FM MONO** switch left in the **OFF** position).

(3) Press the **MEMORY** switch.

- The display will flash (about 10 seconds).



(4) Press the **STATION CALL** switch.

- While the display is flashing, press the switch corresponding to the station which you wish to memorize or re-memorize.

When memorizing a station to Mode 1 (e.g. memorizing a station to No. 9):

By pressing the station call switch once, the station will be memorized to Mode 1 (1-12).



When memorizing a station to Mode 2 (e.g. memorizing a station to No. 21):

By pressing the station call switch twice, the station will be memorized to Mode 2 (13-24).



- After you press the **STATION CALL** switch, the display will flash for about 2 seconds, then the station will be memorized. If you press another switch while the display is flashing, the station will not be memorized.

CONNECTIONS

Accessory FM
T-type antenna

Outdoor FM
antenna

CONNECTING THE FM
T-TYPE ANTENNA AND AM
LOOP ANTENNA

15mm

1. Strip the end of the wires.
2. Wrap the end of the wire in a clockwise direction around the base of the terminals and tighten the terminals to secure.

FM/AM CHANNEL
STEP switch
(Not provided on
Australian or
U.K. Model)

Accessory
AM Loop Antenna

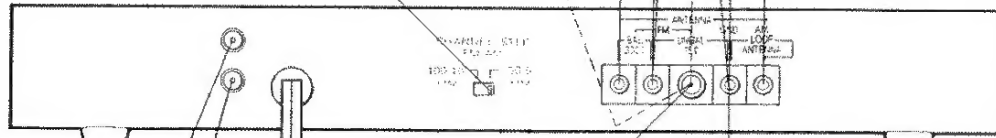

This terminal is
provided on the U.K.
and Australian models.
It is not provided on
multi-voltage model.

Antenna ground
Although grounding is not al-
ways necessary for reception, it
is recommended for protection
against damage from lightning
if an outdoor FM antenna is
used. Grounding is recom-
mended as well to help reduce
noise and hum.

NOTE:
*Never make the ground con-
nection to a gas pipe as sparks
could cause the gas to ignite.*

Connecting the power cord
Plug the power cord into
an AC wall socket.



Illustration not applicable
to U.K. model.

Pin plug connecting cord

- Connect the white plug to the white terminal (L) and the red plug to the red terminal (R).
- Make sure that there is a proper connection.

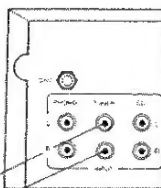
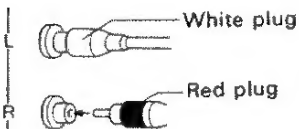

Stereo amplifier

FEATURES

24-station random memory

A total of up to 24 FM and AM stations can be memorized in order to facilitate instant recall of your favorite stations in areas where the frequency bands are crowded with stations.

FM MONO switch

When the FM MONO switch is set to ON, those stereo broadcasts that are drowned out by noise can be tuned in with greater clarity. The FM MONO reception mode can be memorized for individual broadcasting stations.

CHECKING THE ACCESSORIES

AM loop antenna 1



FM T-type antenna 1



Connecting cord with pin plug 1



IMPORTANT 1



The lightning flash with arrowhead, within an equilateral triangle, is intended to alert the user of the presence of uninsulated "dangerous voltage" within the product's enclosure that may be of sufficient magnitude to constitute a risk of electric shock to persons.



CAUTION:
TO PREVENT THE RISK OF ELECTRIC SHOCK, DO NOT REMOVE COVER (OR BACK). NO USER-SERVICEABLE PARTS INSIDE. REFER SERVICING TO QUALIFIED SERVICE PERSONNEL.



The exclamation point within an equilateral triangle is intended to alert the user of the presence of important operating and maintenance (servicing) instructions in the literature accompanying the appliance.

IMPORTANT 2

If the apparatus is fitted with AC mains power outlet(s), see REAR PANEL FACILITIES for convenient connection of additional Hi-Fi component(s). Make all connections to the AC outlet(s) and the signal terminals first. Connect the plug to the wall socket last, make sure that the power switch is off.

FOR USE IN THE UNITED KINGDOM

The wires in this mains lead are coloured in accordance with the following code:

Blue:	Neutral
Brown:	Live

As the colours of the wires in the mains lead of this apparatus may not correspond with the coloured marking identifying the terminals in your plug proceed as follows:

The wire which is coloured blue must be connected to the terminal which is marked with the letter N or coloured black.

The wire which is coloured brown must be connected to the terminal which is marked with the letter L or coloured red.

Equipment sold in the U.K. is not supplied with a power plug.

SAFETY INSTRUCTIONS

READ INSTRUCTIONS — All the safety and operating instructions should be read before the appliance is operated.

RETAIN INSTRUCTIONS — The operating instructions should be retained for future reference.

HEED WARNING — All warnings on the appliance and in the operating instructions should be adhered to.

FOLLOW INSTRUCTIONS — All operating and use instructions should be followed.

WATER AND MOISTURE — The appliance should not be used near water — for example, near a bathtub, washbowl, kitchen sink, laundry tub, in a wet basement, or near a swimming pool, etc.

LOCATION — The appliance should be installed in a stable location.

WALL OR CEILING MOUNTING — The appliance should not be mounted to a wall or ceiling.

VENTILATION — The appliance should be situated so that its location or position does not interfere with its proper ventilation. For example, the appliance should not be situated on a bed, sofa, rug, or similar surface that may block the ventilation openings; or, placed in a built-in installation, such as a bookcase or cabinet that may impede the flow of air through the ventilation openings.

HEAT — The appliance should be situated away from heat sources such as radiators, heat registers, stoves, or other appliances (including amplifiers) that produce heat.

POWER SOURCES — The appliance should be connected to a power supply only of the type described in the operating instructions or as marked on the appliance.

POWER-CORD PROTECTION — Power supply cords should be routed so that they are not likely to be walked on or pinched by items placed upon or against them, paying particular attention to cords at plugs, convenience receptacles, and the point where they exit from the appliance.

POLARIZATION — If your purchased product is provided with a polarized power plug, please read the following instructions. This product is equipped with a polarized alternating current line plug (a plug having one blade wider than the other). This plug will fit into the power outlet only one way. This is a safety feature. If you are unable to insert the plug fully into the outlet, try reversing the plug. If the plug should still fail to fit, contact your electrician to replace your obsolete outlet. Do not defeat the safety purpose of the polarized plug.

CLEANING — The appliance should be cleaned only with a polishing cloth or a soft dry cloth. Never clean with furniture wax, benzene, insecticides or other volatile liquids since they may corrode the cabinet.

POWER LINES — An outdoor antenna should be located away from power lines.

NONUSE PERIODS — The power cord of the appliance should be unplugged from the outlet when left unused for a long period of time.

OBJECT AND LIQUID ENTRY — Care should be taken so that objects do not fall and liquids are not spilled into the enclosure through openings.

DAMAGE REQUIRING SERVICE — The appliance should be serviced by a Pioneer authorized service center or qualified service personnel when:

- The power-supply cord or the plug has been damaged; or
- Objects have fallen, or liquid has been spilled into the appliance; or
- The appliance has been exposed to rain; or
- The appliance does not appear to operate normally or exhibits a marked change in performance; or
- The appliance has been dropped, or the enclosure damaged.

SERVICING — The user should not attempt to service the appliance beyond that described in the operating instructions. For all other servicing, contact the nearest Pioneer authorized service center.

OUTDOOR ANTENNA GROUNDING — If an outside antenna is connected to the antenna terminal, be sure the antenna system is grounded so as to provide some protection against voltage surges and built up static charges.

In the U.S.A., section 810 of the National Electrical Code, ANSI/NFPA No. 70-1984, provides information with respect to proper grounding of the mast and supporting structure, grounding of the lead-in wire to an antenna discharge unit, size of grounding conductors, location of antenna discharge unit, connection to grounding electrodes, and requirements for the grounding electrode. See Fig. A.

CART — An appliance and cart combination should be moved with care. Quick stops, excessive force, and uneven surfaces may cause the appliance and cart combination to overturn.

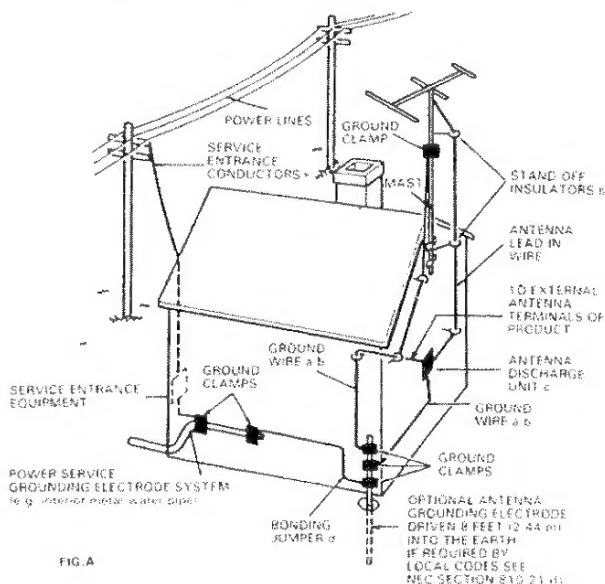

- a) Use No. 10 AWG (5.3 mm²) copper, No. 8 AWG (8.4 mm²) aluminum, No. 17 AWG (1.0 mm²) copper-clad steel, bronze wire, or larger as ground wire.
- b) Secure antenna lead-in and ground wires to house with stand-off insulators spaced from 4 feet (1.22 meters) to 6 feet (1.83 meters) apart.
- c) Mount antenna discharge unit as closely as possible to where lead-in enters house.
- d) Use jumper wire not smaller than No. 6 AWG (13.3 mm²) copper, or the equivalent, when a separate antenna grounding electrode is used. See NEC Section 810.21 (1).